



8-9 Additional Practice

Scan for
Multimedia



1. Find the volume of the cube shown at the right.

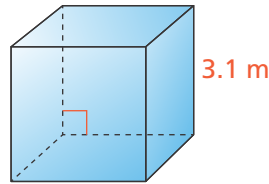

2. Find the volume of the triangular prism shown.

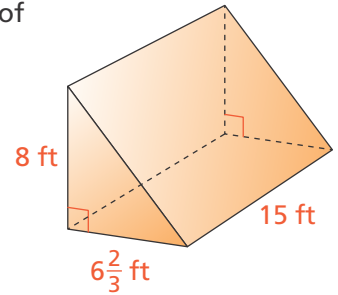

3. Find the volume of the hexagonal prism shown at the right. Round to the nearest hundredth.

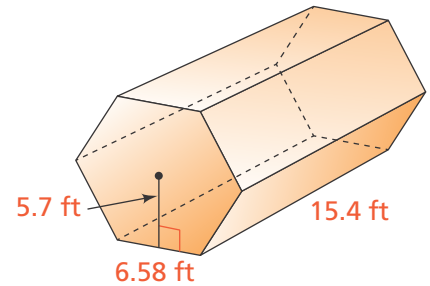

4. The walls of an empty grain silo form a hexagonal prism as shown at the right. Can the farmer store 4,250 cubic feet of grain inside the silo? Explain.

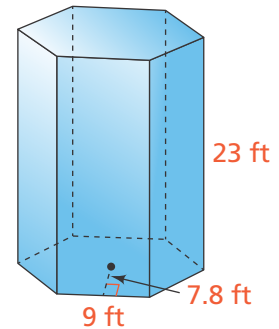

5. A rain gutter attached to the edge of a roof has the shape of a rectangular prism. It is 18 feet long and 7 inches high. It has a volume of 7,560 cubic inches. How wide is the gutter?

6. **Make Sense and Persevere** A baker makes a layered cake with two layers that are rectangular prisms. Each layer is 2 inches tall. What is the volume of the cake? © MP.1

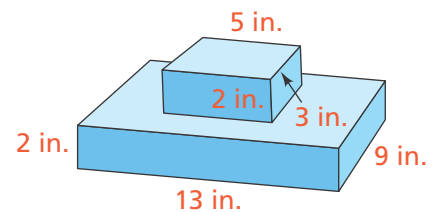

7. The triangular prism shown at the right has two bases that are equilateral triangles. The perimeter of each base measures 63 cm. What is the volume of the prism?

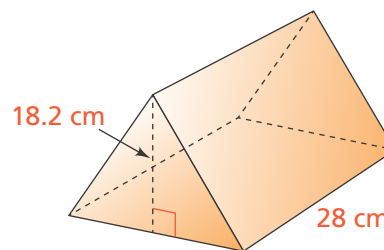

8. **Make Sense and Persevere** Morgan made the display block shown. What is the volume of the block? Explain your answer. © MP.1

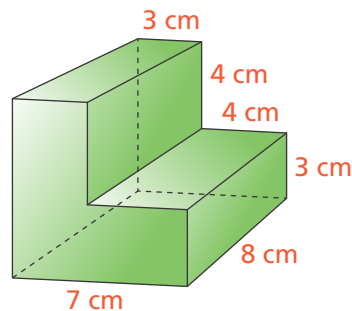

9. **Higher Order Thinking** A steel tube is constructed in the shape of a regular hexagonal prism with a smaller regular hexagonal prism removed. The material used for the tube weighs 4 grams per cubic centimeter. How much does the tube weigh? Explain your reasoning.

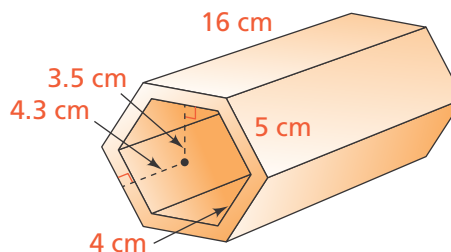

© Assessment Practice

10. What is the volume of the triangular prism shown at the right? Explain your answer.

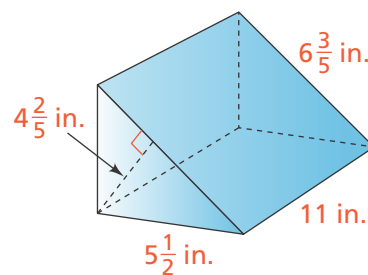

11. Before adding flowers, James fills the vase shown $\frac{1}{3}$ full with water. How much water does it take to fill the vase $\frac{1}{3}$ full? Explain your answer.

